

IEC Appliance Inlet C14 with Filter, Fuseholder 1-pole

Plug removal necessary for fuse replacement



Type 5200, Fuseholder 1-pole with spare compartment
Screw-On Version

Type 5200, Fuseholder 1-pole with spare compartment
Snap-In Version



Description

- Panel Mount:
Snap-in or screw-on mounting from front side
- 3 Functions:
Appliance Inlet Protection class I, Fuseholder for fuse-links 5 x 20 mm 1-pole, Line filter in standard and medical version
- Quick connect terminals 6.3 x 0.8 mm

Approvals

- VDE Certificate Number: 101307
- UL File Number: E72928

Characteristics

- All single elements are already wired
- Plug removal necessary for fuse-link replacement
Fuse drawer meets requirements of medical standard IEC/EN 60601-1
The fuseholder is accessible from the equipment front
- Suitable for use in equipment according to IEC/UL 60950
Suitable for use in medical equipment according to IEC/UL 60601-1

References

- Alternative: version without line filter [6200](#)
- Alternative: Standard version

Weblinks

[pdf-datasheet](#), [html-datasheet](#), [General Product Information](#), [Approvals](#), [CE declaration of conformity](#), [RoHS](#), [CHINA-RoHS](#), [Mating Connectors](#), [e-Shop](#), [SCHURTER-Stock-Check](#), [Distributor-Stock-Check](#), [CAD-Drawings](#), [Accessories](#), [Mounting instruction](#), [Detailed request for product](#)

Technical Data

Ratings IEC	1 - 10A @ Ta 40 °C / 250 VAC; 50Hz
Ratings UL/CSA	1 - 10A @ Ta 40 °C / 125 VAC; 60Hz
Leakage Current	standard < 0.5 mA (250 V / 60Hz) medical < 5 µA (250 V / 60 Hz)
Dielectric Strength	> 1.7 kVDC between L-N > 2.7 kVDC between L/N-PE Test voltage (2 sec)
Allowable Operation Temp.	-25 °C to 85 °C
Climatic Category	25/085/21 acc. to IEC 60068-1
Degree of Protection	from front side IP 40 acc. to IEC 60529
Protection Class	Suitable for appliances with protection class I acc. to IEC 61140
Terminal	Quick connect terminals 6.3 x 0.8 mm
Panel Thickness s	Screw: max 8 mm Mounting screw torque max 0.5Nm Snap-in: 0.8 mm to 3 mm
Material: Housing	Thermoplastic, black, UL 94V-0

Appliance-Inlet/-Outlet	C14 acc. to IEC 60320, UL 498, CSA C22.2 no. 42 (for cold conditions) pin-temperature 70 °C, 10A, Protection Class I
Fuseholder	1-pole, Shocksafe category PC2 acc. to IEC 60127-6, for fuse-links 5 x 20 mm
Rated Power Acceptance @ Ta 23 °C	5 x 20: 2 W (1 pole)
Power Acceptance @ Ta > 23°C	Admissible power acceptance at higher ambient temperature see derating curves
Line Filter	Standard and Medical Version, IEC 60939, UL 1283, CSA C22.2 no. 8 Technical Details
MTBF	> 2'300'000 h acc. to MIL-HB-217 F

Dimension

Screw-on mounting type 5200

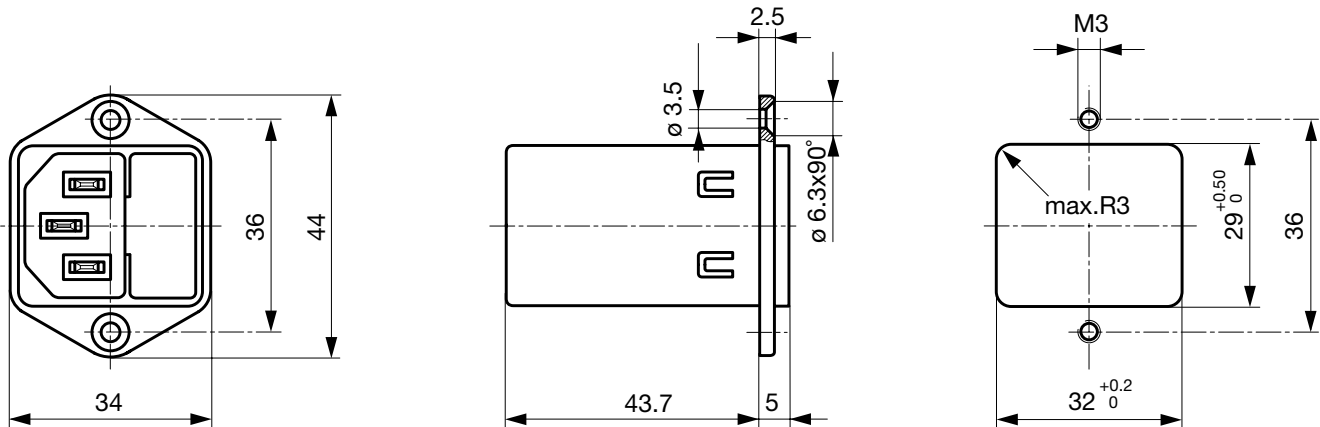

Snap-in mounting type 5200

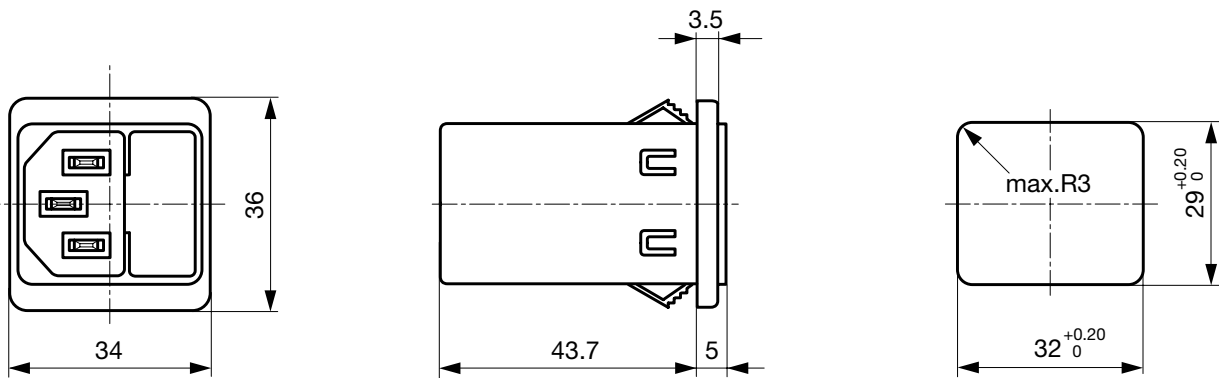
**Technical Data of Filter-Components**

Rated Current [A]	Filter-Type	Inductances L [mH]	Capacitance CX [nF]	Capacitance CY [nF]	R [MΩ]
1	Standard Version	2 x 11	47	2.2	-
2	Standard Version	2 x 4	47	2.2	-
4	Standard Version	2 x 1.6	47	2.2	-
6	Standard Version	2 x 0.7	47	2.2	-
8	Standard Version	2 x 0.6	47	2.2	-
10	Standard Version	2 x 0.4	47	2.2	-
1	Medical Version (M5)	2 x 11	47	-	1
2	Medical Version (M5)	2 x 4	47	-	1
4	Medical Version (M5)	2 x 1.6	47	-	1
6	Medical Version (M5)	2 x 0.7	47	-	1
8	Medical Version (M5)	2 x 0.6	47	-	1
10	Medical Version (M5)	2 x 0.4	47	-	1
10	Standard and Medical Version	2 x 11	47	2.2	1

Diagrams

5200 Standard version

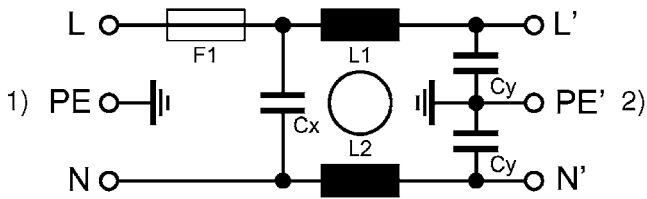

- 1) Line
- 2) Load

5200 Medical version

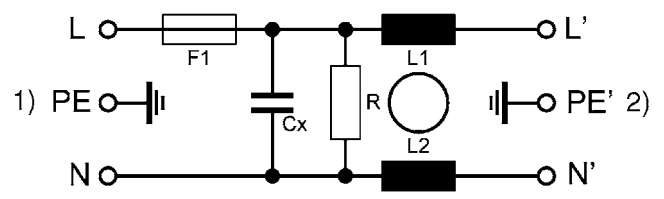

- 1) Line
- 2) Load

Derating Curves

1-pole

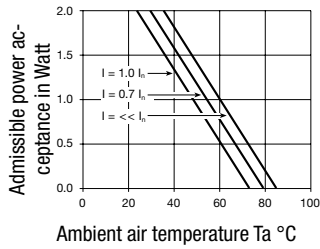

Attenuation Loss

Standard version

--- differential mode ____ common mode

1 A

2 A

4 A

6 A

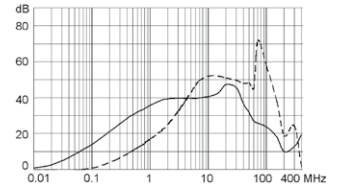
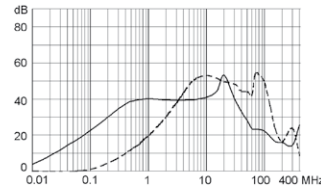
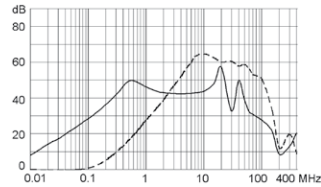
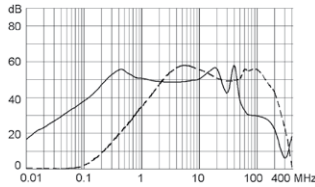

8 A

10 A

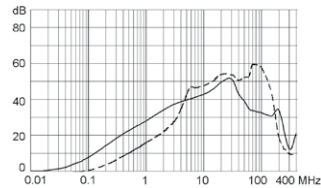
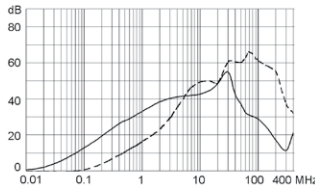

Medical version (M5)

1 A

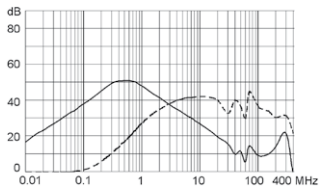

2 A

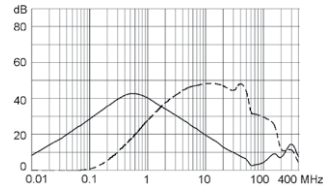

4 A

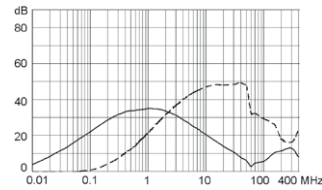

6 A

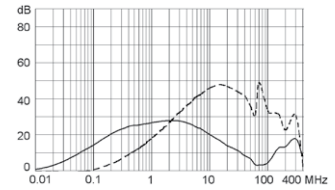

8 A

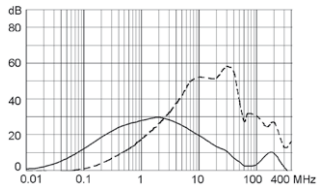

10 A

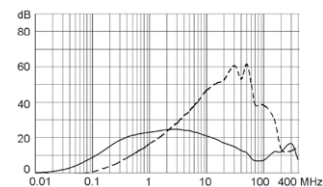

Variants

Rated Current [A]	Filter-Type	Panel mounting	Fuseholder	Order Number	
1	Standard Version	Screw	1-pole	5200.0123.1	■
2	Standard Version	Screw	1-pole	5200.0223.1	■
4	Standard Version	Screw	1-pole	5200.0423.1	■
6	Standard Version	Screw	1-pole	5200.0623.1	■
8	Standard Version	Screw	1-pole	5200.0823.1	
10	Standard Version	Screw	1-pole	5200.1023.1	■
1	Standard Version	Snap-in	1-pole	5200.0143.1	■
2	Standard Version	Snap-in	1-pole	5200.0243.1	■
4	Standard Version	Snap-in	1-pole	5200.0443.1	■
6	Standard Version	Snap-in	1-pole	5200.0643.1	■
8	Standard Version	Snap-in	1-pole	5200.0843.1	
10	Standard Version	Snap-in	1-pole	5200.1043.1	■
1	Medical Version (M5)	Screw	1-pole	5200.0123.3	
2	Medical Version (M5)	Screw	1-pole	5200.0223.3	
4	Medical Version (M5)	Screw	1-pole	5200.0423.3	
6	Medical Version (M5)	Screw	1-pole	5200.0623.3	
8	Medical Version (M5)	Screw	1-pole	5200.0823.3	
10	Medical Version (M5)	Screw	1-pole	5200.1023.3	
1	Medical Version (M5)	Snap-in	1-pole	5200.0143.3	
2	Medical Version (M5)	Snap-in	1-pole	5200.0243.3	
4	Medical Version (M5)	Snap-in	1-pole	5200.0443.3	
6	Medical Version (M5)	Snap-in	1-pole	5200.0643.3	
8	Medical Version (M5)	Snap-in	1-pole	5200.0843.3	
10	Medical Version (M5)	Snap-in	1-pole	5200.1043.3	

■ Most Popular.

Availability for all products can be searched real-time: <http://www.schurter.com/en/Stock-Check/Stock-Check-SCHURTER>

Packaging unit

10 Pcs

Accessories

Description

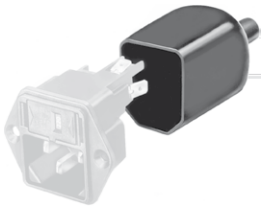

Assorted Covers
Rear Cover



Cord retaining kits
Cord retaining strain relief

Mating Outlets/Connectors

Category / Description



Appliance Outlet Overview complete

IEC Appliance Outlet F, Screw-on Mounting, Front Side, Solder Terminal	4787
IEC Appliance Outlet F, Snap-in Mounting, Front Side, Solder or Quick-connect Terminal	4788
IEC Appliance Outlet F or H, Screw-on Mounting, Front Side, Solder, PCB or Quick-connect Terminal	5091

[Appliance Outlet further types to 5200](#)



Connector Overview complete

IEC Connector C15A, Rewireable, Straight	0102
IEC Connector C15A, Rewireable, Straight	0102-G
IEC Connector C15A, Rewireable, Angled	0112
IEC Connector C13, Rewireable, Angled	4012
IEC Connector C13, Rewireable, Straight	4022

[Connector further types to 5200](#)

...