

Metal Switch Short Stroke



metal switch
 Point Illumination
 red / green



metal switch
 lettered



metal switch
 Point Illumination
 blue

See below:

[Approvals and Compliances](#)

Description

- Momentary action switch available in version Standard, with Point Illumination, Lettering, varnished in different colours
- Assembly by mounting with nut
- Pin connections, Pins with Soldering Aid or Clip for Pins

Characteristics

- Housing zinc die-cast with nickel plating and two actuator material types: zinc die-cast with nickel plating or stainless steel
- Wide range of materials, colours, lettering, colours of illumination
- Switching voltage max. 48 VDC, switching current max. 125 mA
- Zinc die-cast for housing and actuator
 - For indoor use, no illumination, no lettering
- Stainless Steel for actuator
 - Optional point illumination and laser lettering with standard or customer-specific symbols
- Stainless Steel for housing and actuator
 - for use in harsh environments outdoors (see technical data)
- Varnished Version
 - Colour adjustments to customer housings possible, as standard: Signal colors red, green and yellow, optional: housing or actuator varnishing according to provided color specifications (MOQ 1'000 pcs)

Weblinks

[pdf data sheet](#), [html datasheet](#), [General Product Information](#), [CAD-Drawings](#), [Product News](#), [Detailed request for product](#)

Technical Data

Electrical Data

Switching Function	N.O.
Supply Voltage	LED operating data are listed in separate table

Contact Material Silver

Switching Voltage	min. 4 VDC , max. 48 VDC
Switching Current	max. 125 mA
Rated Switching Capacity	1.2 W
Lifetime	1 million actuations at Rated Switching Capacity
Contact Resistance	< 50mΩ, < 150 mΩ after lifetime
Insulation Resistance	> 100 MΩ
Duration of Bounce	< 1 ms

Contact Material Gold

Switching Voltage	min. 50 mVDC, max. 24 VDC
Switching Current	max. 80 mA
Rated Switching Capacity	0.36 W
Lifetime	1 million actuations at Rated Switching Capacity
Contact Resistance	< 50mΩ, < 150 mΩ after lifetime
Insulation Resistance	> 100 MΩ
Duration of Bounce	< 1 ms

Mechanical Data

Actuating Force	3.7 N
Actuating Travel	0.4 mm
Lifetime	1 million actuations
Shock Protection	IK06
Mounting screw torque	0.4 Nm with Sealing Ring, 1.5 Nm without Sealing Ring

Climatical Data

Operating Temperature	-20 to 60 °C
Storage Temperature	-20 to 60 °C
Protection Class	IP67 with O-Ring
Salt Spray Test (acc. to DIN 50021-SS)	24 h / 48 h / 96 h Residence Time

Other Data

Contact Material	Ag / Au
------------------	---------

Soldering Data

Tinning	260 °C / 2 sec according to DIN IEC 60068-2-20
Solderability	260 °C / 2 sec (IEC 60068-2-20 Test Ta Method 1)
Resistance to Soldering Heat	260 °C / 5 sec (IEC 60068-2-20 Test Tb Method 1A)

Material

Housing	Stainless Steel 1.4301 / Zinc Die Casting Nickel Plated
Actuator unlettered	Zinc Die Casting Nickel Plated
Actuator lettered	Stainless Steel
Contact	CuZn37 2,5 μm Ag
Snap Dome	X 12 CrNi 177 gold plated
Socket	PA

Detailed information on product approvals, code requirements, usage instructions and detailed test conditions can be looked up in [Details about Approvals](#)

SCHURTER products are designed for use in industrial environments. They have approvals from independent testing bodies according to national and international standards. Products with specific characteristics and requirements such as required in the automotive sector according to IATF 16949, medical technology according to ISO 13485 or in the aerospace industry can be offered exclusively with customer-specific, individual agreements by SCHURTER.

Application standards

Application standards where the product can be used

Organization	Design	Standard	Description
	Designed for applications acc.	IEC/UL 62368-1	Audio/video, information and communication technology equipment - Part 1: Safety requirements

Compliances

The product complies with following Guide Lines

Identification	Details	Initiator	Description
	RoHS	SCHURTER AG	Directive RoHS 2011/65/EU, Amendment (EU) 2015/863
	REACH	SCHURTER AG	On 1 June 2007, Regulation (EC) No 1907/2006 on the Registration, Evaluation, Authorization and Restriction of Chemicals 1 (abbreviated as "REACH") entered into force.

Dimension [mm]

MCS 19

MCS 19 Connection Versions

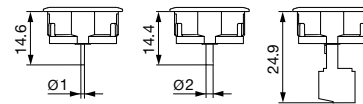
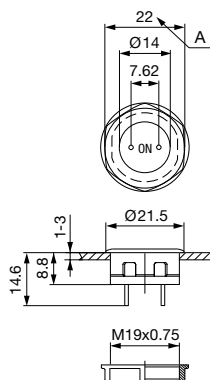

Drawing 1: Pins
 Drawing 2: Pins with Soldering Aid
 Drawing 3: Clip for Pins

MCS 19 PI

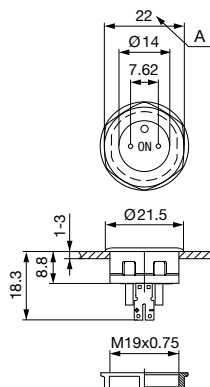

Legend:
 Zinc Die Casting Version:
 x = 1 mm without sealing ring
 x = 2 mm with sealing ring
 Stainless Steel Version:
 x = 1 mm without sealing ring
 x = 1,7 mm with sealing ring

Dimension

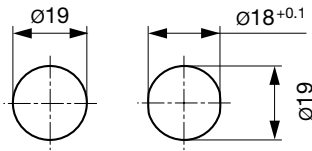

Drilling diagram

Diagrams

MCS 19 PI Bi-colour-LED

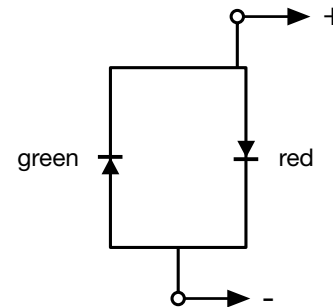
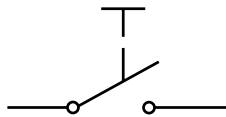

Point Illumination

Operating Data	Forward Current max.	Forward Voltage at 10 mA	Forward Voltage max.
LED red	30 mA	1.9 VDC	3.0 VDC
LED green	30 mA	2.4 VDC	3.0 VDC
LED yellow	30 mA	2.4 VDC	3.0 VDC
LED blue	20 mA	3.8 VDC	4.5 VDC
LED red/green	25 mA	2.0 VDC	2.5 VDC

Attention: Switches are delivered without series resistor.

Marking

The last three digits in the order number define the lettering:

000	No Lettering
001-074	Standard Lettering
101-	Customized Lettering

Order example for labeling

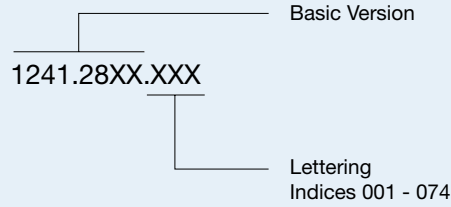

Order example labeling for varnished variants

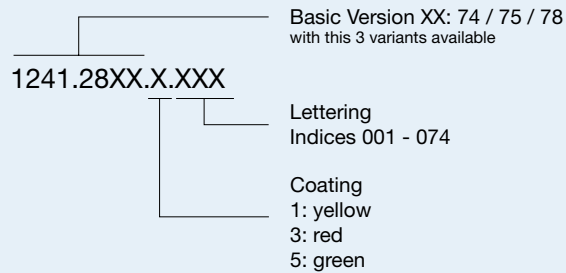

Lettering Colour of Laser Lettering

Material	Lettering Colour	
Stainless Steel	black	Filled letters

Order Index Lettering

Laser Marking			
001 =A	021 =U	041 =÷	061 =EIN
002 =B	022 =V	042 =*	062 =AUS
003 =C	023 =W	043 =	063 =AUF
004 =D	024 =X	044 =#	064 =AB
005 =E	025 =Y	045 =↔	065 =ON
006 =F	026 =Z	046 =‡	066 =OFF
007 =G	027 =0	047 =→	067 =UP
008 =H	028 =1	048 =←	068 =DOWN
009 =I	029 =2	049 =↓	069 =HIGH
010 =J	030 =3	050 =↑	070 =LOW
011 =K	031 =4	051 =%	071 =ON/OFF
012 =L	032 =5	052 =√	072 =START
013 =M	033 =6	053 =CTRL	073 =RESET
014 =N	034 =7	054 =RETURN	074 =⏻
015 =O	035 =8	055 =SHIFT	075 =💡
016 =P	036 =9	056 =LOCK	076 =🔔
017 =Q	037 =+	057 =STOP	077 =Ⓜ
018 =R	038 =-	058 =ENTER	
019 =S	039 =.	059 =BACK	
020 =T	040 =x	060 =LINE	

Please note that the font size depends on the number of characters

All Variants

Terminal	Contact	Housing Material	Actuator Material	Varnish	Illumination	Color LED	Config. Code	Order Number
Pins	Ag	Zinc Diecasting	Zinc Diecasting	-	non-illuminated	-	MCS 19 Zinc	1241.2800
Pins with Soldering Aid	Ag	Zinc Diecasting	Zinc Diecasting	-	non-illuminated	-	MCS 19 Zinc	1241.2801
Screw terminal	Ag	Zinc Diecasting	Zinc Diecasting	-	non-illuminated	-	MCS 19 Zinc	1241.2802
Pins	Ag	Zinc Diecasting	Stainless Steel	-	non-illuminated	-	MCS 19 Zinc/Stainless Steel	1241.2805
Pins with Soldering Aid	Ag	Zinc Diecasting	Stainless Steel	-	non-illuminated	-	MCS 19 Zinc/Stainless Steel	1241.2806
Screw terminal	Ag	Zinc Diecasting	Stainless Steel	-	non-illuminated	-	MCS 19 Zinc/Stainless Steel	1241.2807
Pins	Au	Zinc Diecasting	Zinc Diecasting	-	non-illuminated	-	MCS 19 Zinc	1241.2810
Screw terminal	Au	Zinc Diecasting	Zinc Diecasting	-	non-illuminated	-	MCS 19 Zinc	1241.2812
Pins	Au	Zinc Diecasting	Stainless Steel	-	non-illuminated	-	MCS 19 Zinc/Stainless Steel	1241.2815
Screw terminal	Au	Zinc Diecasting	Stainless Steel	-	non-illuminated	-	MCS 19 Zinc/Stainless Steel	1241.2817
Pins	Ag	Stainless Steel	Stainless Steel	-	non-illuminated	-	MCS 19 ES	1241.2820
Pins with Soldering Aid	Ag	Stainless Steel	Stainless Steel	-	non-illuminated	-	MCS 19 ES	1241.2821
Screw terminal	Ag	Stainless Steel	Stainless Steel	-	non-illuminated	-	MCS 19 ES	1241.2822
Screw terminal	Au	Stainless Steel	Stainless Steel	-	non-illuminated	-	MCS 19 ES	1241.2827
Pins with Soldering Aid	Ag	Stainless Steel	Stainless Steel	-	Point Illumination	red	MCS 19 PI	1241.2830
Pins with Soldering Aid	Ag	Stainless Steel	Stainless Steel	-	Point Illumination	green	MCS 19 PI	1241.2831
Pins with Soldering Aid	Ag	Stainless Steel	Stainless Steel	-	Point Illumination	yellow	MCS 19 PI	1241.2832
Pins with Soldering Aid	Ag	Stainless Steel	Stainless Steel	-	Point Illumination	red / green	MCS 19 PI	1241.2833
Pins with Soldering Aid	Ag	Stainless Steel	Stainless Steel	-	Point Illumination	blue	MCS 19 PI	1241.2834
Pins with Soldering Aid	Ag	Zinc Diecasting	Stainless Steel	-	Point Illumination	red	MCS 19 PI	1241.2855
Pins with Soldering Aid	Ag	Zinc Diecasting	Stainless Steel	-	Point Illumination	green	MCS 19 PI	1241.2856
Pins with Soldering Aid	Ag	Zinc Diecasting	Stainless Steel	-	Point Illumination	yellow	MCS 19 PI	1241.2857
Pins with Soldering Aid	Ag	Zinc Diecasting	Stainless Steel	-	Point Illumination	red / green	MCS 19 PI	1241.2858
Pins with Soldering Aid	Ag	Zinc Diecasting	Stainless Steel	-	Point Illumination	blue	MCS 19 PI	1241.2859
Pins with Soldering Aid	Ag	Zinc Diecasting	Stainless Steel	Housing green	non-illuminated	-	MCS 19 Zinc/Stainless Steel	1241.2874.5
Screw terminal	Ag	Zinc Diecasting	Stainless Steel	Housing yellow	non-illuminated	-	MCS 19 Zinc/Stainless Steel	1241.2875.1
Pins with Soldering Aid	Ag	Zinc Diecasting	Stainless Steel	Actuator red	non-illuminated	-	MCS 19 Zinc/Stainless Steel	1241.2878.3

For Lettering versions see table "Order Index Lettering" to determine the symbol

Nut with gasket are enclosed in the box.

Most Popular.

Availability for all products can be searched real-time: <https://www.schurter.com/en/Stock-Check/Stock-Check-SCHURTER>

Packaging unit

20 in box with insert (20 pcs, with connecting terminal 10 pcs.)



- Actuating elements in ESD safe packaging
- Screw nuts and sealing O-ring in a bag (enclosed in the box)

- Actuating elements in ESD safe packaging
- Screw nuts and sealing O-ring in a bag (enclosed in the box)

Accessories

Description



Connecting Terminal MCS
 Connecting Terminal