

DC Fan



# 120×120×25 mm

**San Ace 120 9G type** Model 9G1212B401 is not certified.

## General Specifications

- Material ..... Frame: Plastic (Flammability: UL 94V-0), Impeller: Plastic (Flammability: UL 94V-1)
- Expected life ..... See the table below. (L10 life: 90% survival rate for continuous operation in free air at 60°C, rated voltage)  
Expected life at 40°C is for reference only.
- Motor protection function ..... Locked rotor burnout protection, Reverse polarity protection  
For details, please refer to p. 573.
- Dielectric strength ..... 50/60 Hz, 500 VAC, for 1 minute (between lead wire conductors and frame)
- Insulation resistance ..... 10 MΩ or more with a 500 VDC megger (between lead wire conductors and frame)
- Sound pressure level (SPL) ..... At 1 m away from the air inlet
- Storage temperature ..... -30 to +70°C (Non-condensing)
- Lead wire ..... ⊕Red ⊖Black or Blue Sensor Yellow
- Mass ..... 240 g

## Specifications

The models listed below **have ribs and pulse sensors**. For models without ribs, append "1" to the end of model numbers.

Model no.	Rated voltage [V]	Operating voltage range [V]	Rated current [A]	Rated input [W]	Rated speed [min <sup>-1</sup> ]	Max. airflow [m <sup>3</sup> /min] [CFM]	Max. static pressure [Pa] [inchH <sub>2</sub> O]	SPL [dB (A)]	Operating temperature [°C]	Expected life [h]	
» 9G1212G401	12	10.2 to 13.8	0.9	10.8	4100	3.68 130	120 0.482	51	-20 to +70	40000/60°C (70000/40°C)	
» 9G1212E401			0.58	6.96	3650	3.25 115	98 0.394	48			
» 9G1212A401			0.4	4.8	3150	2.83 100	77 0.309	44			
» 9G1212H401		6 to 13.8	0.31	3.72	2850	2.5 88	64 0.257	40			
» 9G1212F401		7 to 13.8	0.19	2.28	2250	1.98 70	42 0.169	35			
» 9G1212M401			0.14	1.68	1950	1.66 59	31 0.124	29			
» 9G1212B401		10.2 to 13.8	0.06	0.72	1000	0.88 31	9.6 0.039	18			
» 9G1224G401		24	20.4 to 27.6	0.47	11.28	4100	3.68 130	120 0.482			51
» 9G1224E401				0.37	8.88	3650	3.25 115	98 0.394			48
» 9G1224A401				0.21	5.04	3150	2.83 100	77 0.309			44
» 9G1224H401	12 to 27.6		0.17	4.08	2850	2.5 88	64 0.257	40			
» 9G1224F401	20.4 to 27.6		0.1	2.4	2250	1.98 70	42 0.169	35			
» 9G1224M401			0.08	1.92	1950	1.66 59	31 0.124	29			
» 9G1248G401	48		40.8 to 55.2	0.23	11.04	4100	3.68 130	120 0.482	51		
» 9G1248E401				0.16	7.68	3650	3.25 115	98 0.394	48		
» 9G1248A401				0.13	6.24	3150	2.83 100	77 0.309	44		
» 9G1248H401				0.1	4.8	2850	2.5 88	64 0.257	40		
» 9G1248F401		0.06		2.88	2250	1.98 70	42 0.169	35			
» 9G1248M401		0.05		2.4	1950	1.66 59	31 0.124	29			

The following sensor and control options are available for selection.

Differs according to the model. Refer to the table on pp. 601 to 602. Without sensor Lock sensor PWM control

The » mark indicates Short LeadTime Service applicable models. See p. 626 for details.

# Airflow - Static Pressure Characteristics

**9G1212G401** With pulse sensor

Operating voltage range

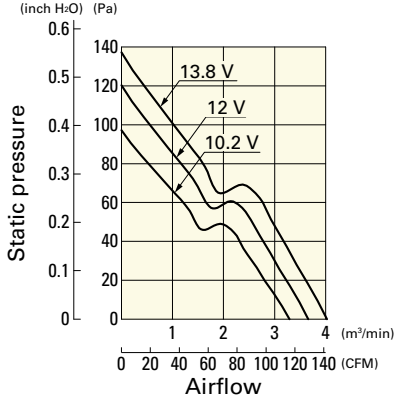

**9G1212E401** With pulse sensor

Operating voltage range

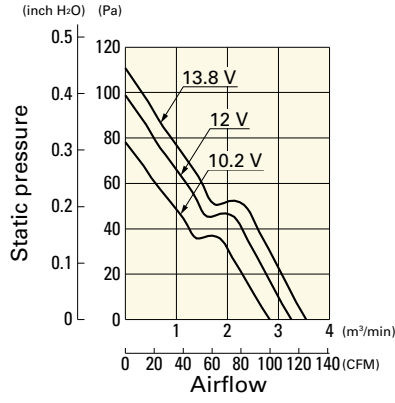

**9G1212A401** With pulse sensor

Operating voltage range

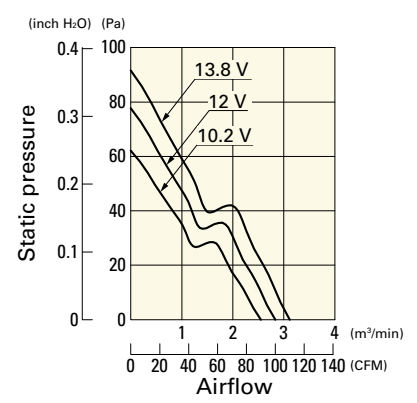

**9G1212H401** With pulse sensor

Operating voltage range

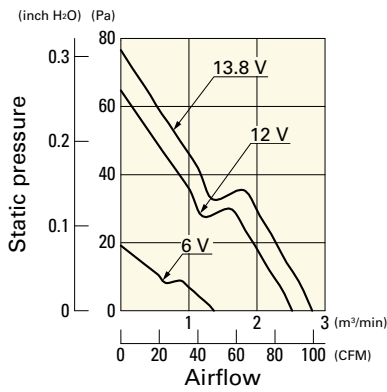

**9G1212F401** With pulse sensor

Operating voltage range

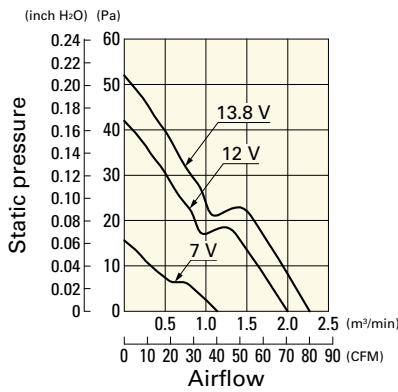

**9G1212M401** With pulse sensor

Operating voltage range

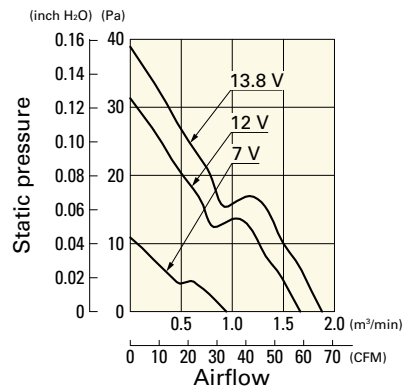

**9G1212B401** With pulse sensor

Operating voltage range

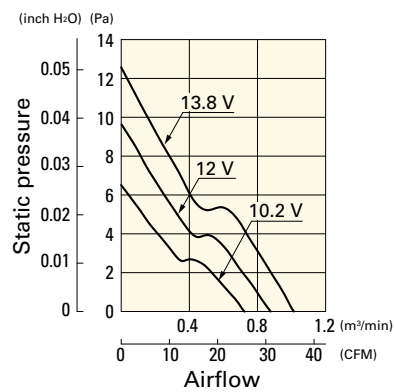

**9G1224G401** With pulse sensor

Operating voltage range

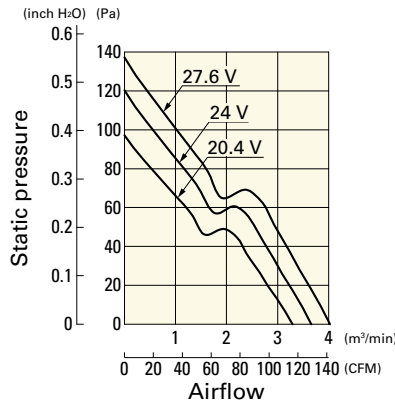

**9G1224E401** With pulse sensor

Operating voltage range

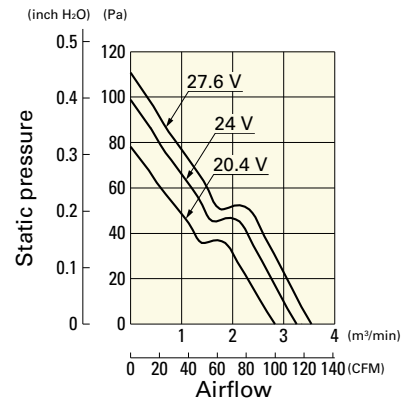

**9G1224A401** With pulse sensor

Operating voltage range

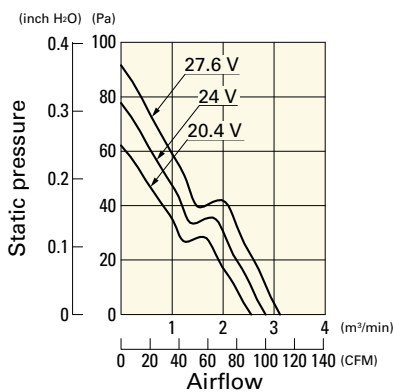

**9G1224H401** With pulse sensor

Operating voltage range

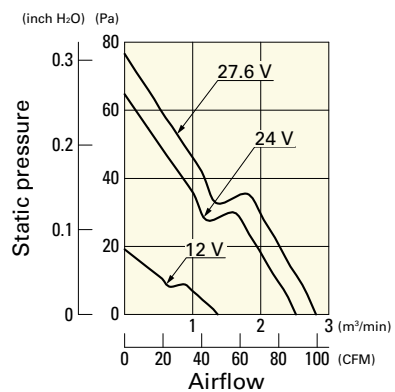

**9G1224F401** With pulse sensor

Operating voltage range

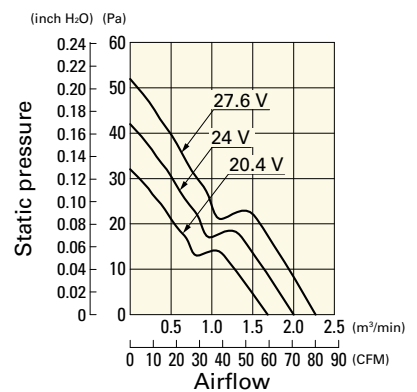

**Airflow - Static Pressure Characteristics**

**9G1224M401** With pulse sensor

Operating voltage range

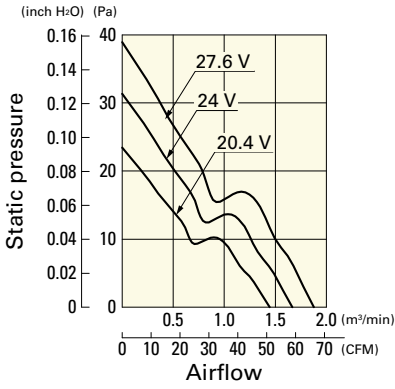

**9G1248G401** With pulse sensor

Operating voltage range

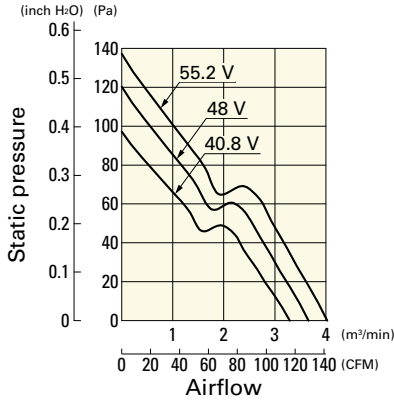

**9G1248E401** With pulse sensor

Operating voltage range

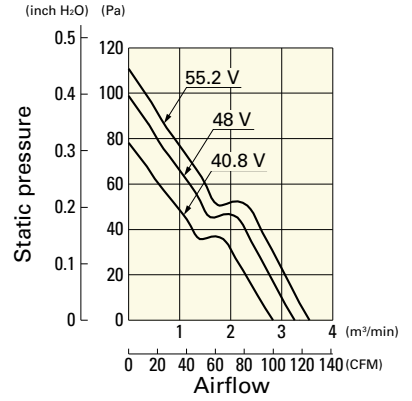

**9G1248A401** With pulse sensor

Operating voltage range

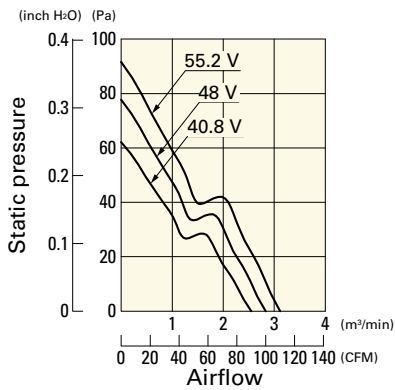

**9G1248H401** With pulse sensor

Operating voltage range

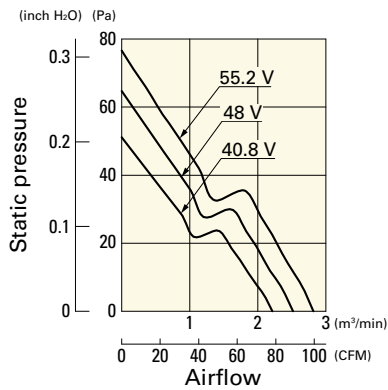

**9G1248F401** With pulse sensor

Operating voltage range

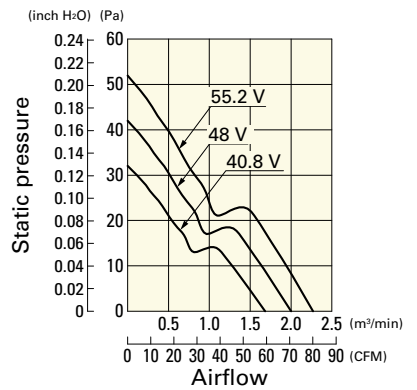

**9G1248M401** With pulse sensor

Operating voltage range

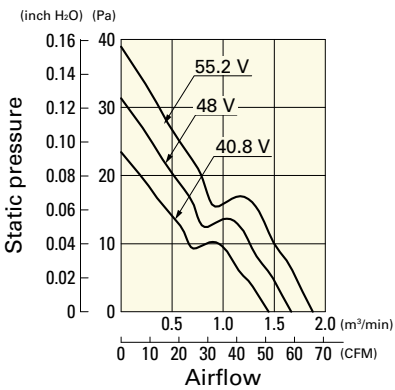

**Dimensions (unit: mm)** (With ribs)

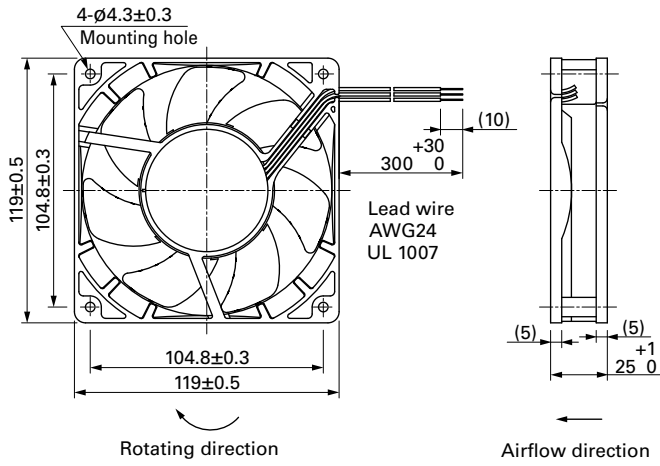

**Reference Dimensions of Mounting Holes and Vent Opening (unit: mm)**

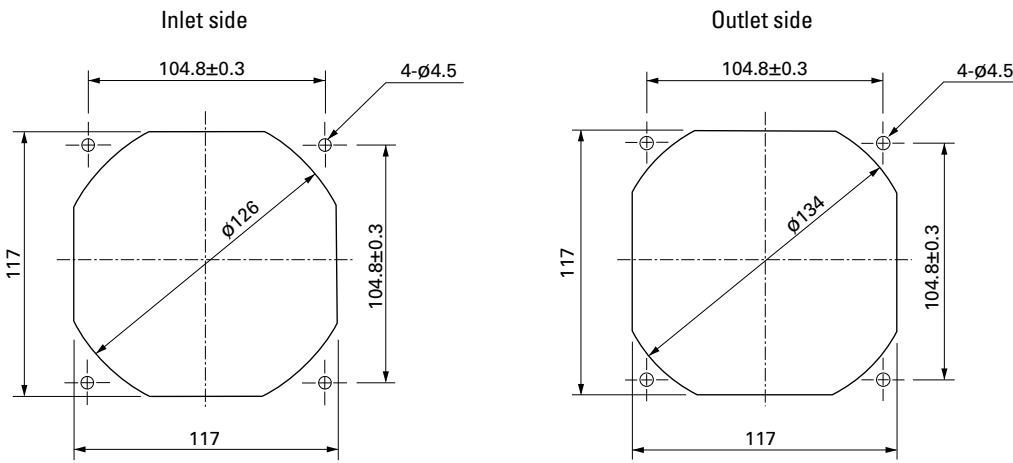

**Options**

Finger guards

page: p. 559

Model no.: 109-019E, 109-019K, 109-019C, 109-019H

Resin finger guards

page: p. 565

Model no.: 109-1000G

Resin filter kits

page: p. 566

Model no.: 109-1000F13 (13PPI), 109-1000F20 (20PPI),  
109-1000F30 (30PPI), 109-1000F40 (40PPI)